

4-1L

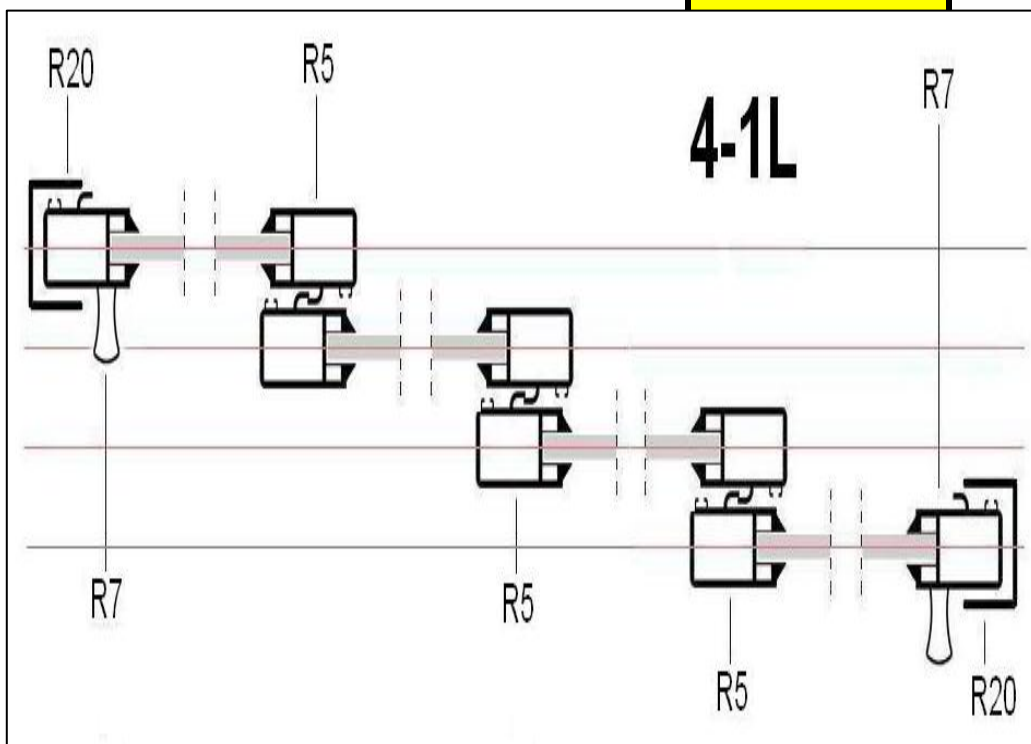

4-1L A

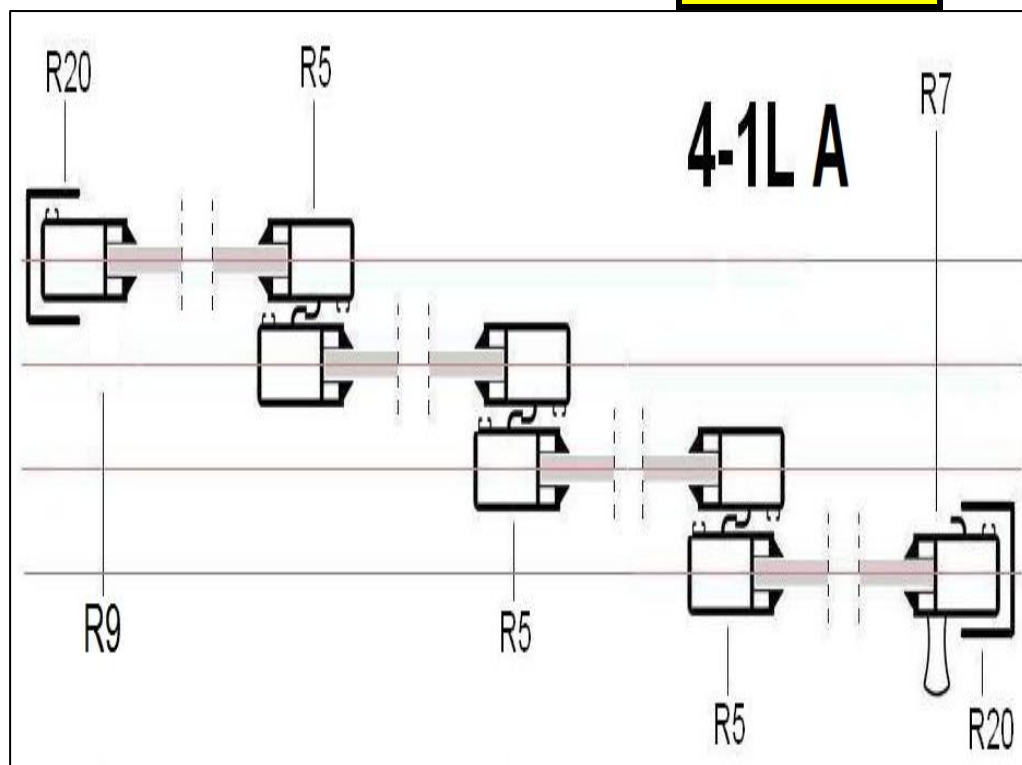

4-1L B

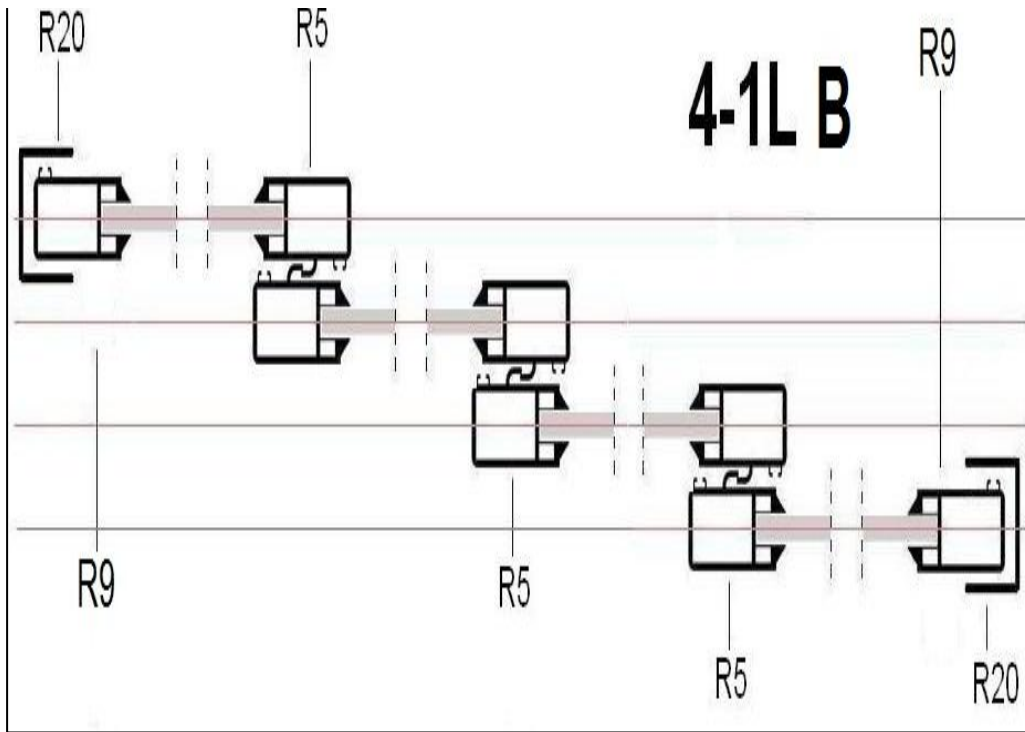

**4-1LC**

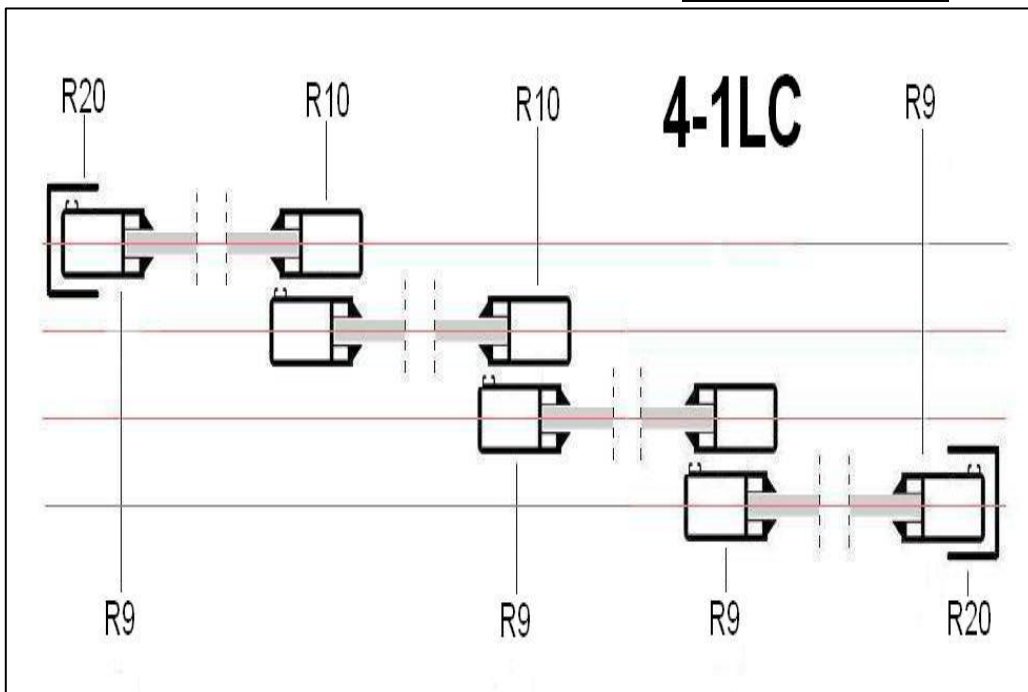

**4-2L REGULOWANY**

**4-2L**

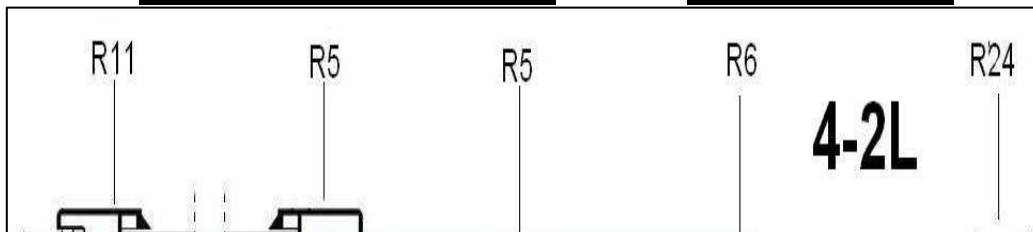

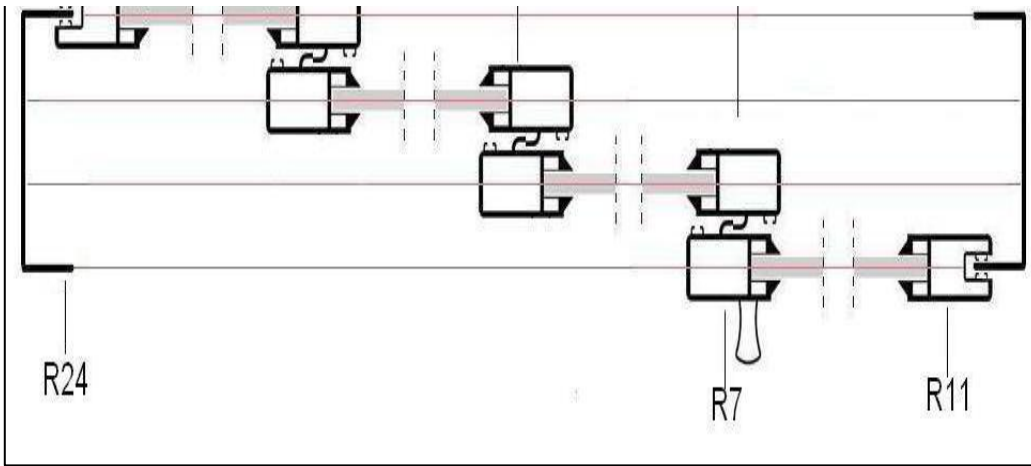

**4-2L A**

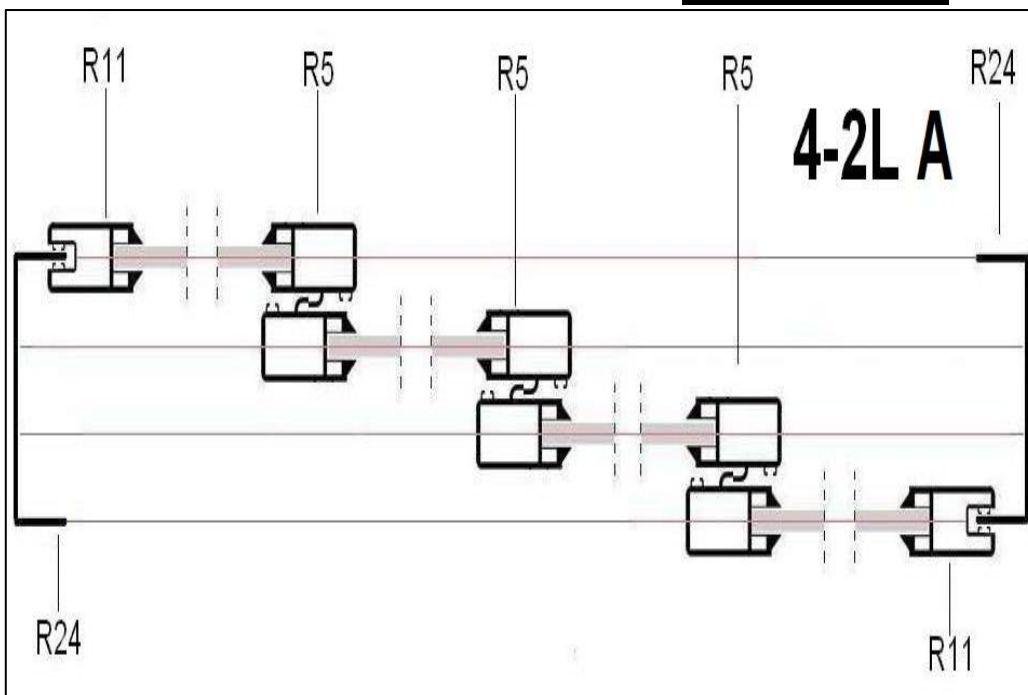

**4-2LB REGULOWANY**

**4-2LB**

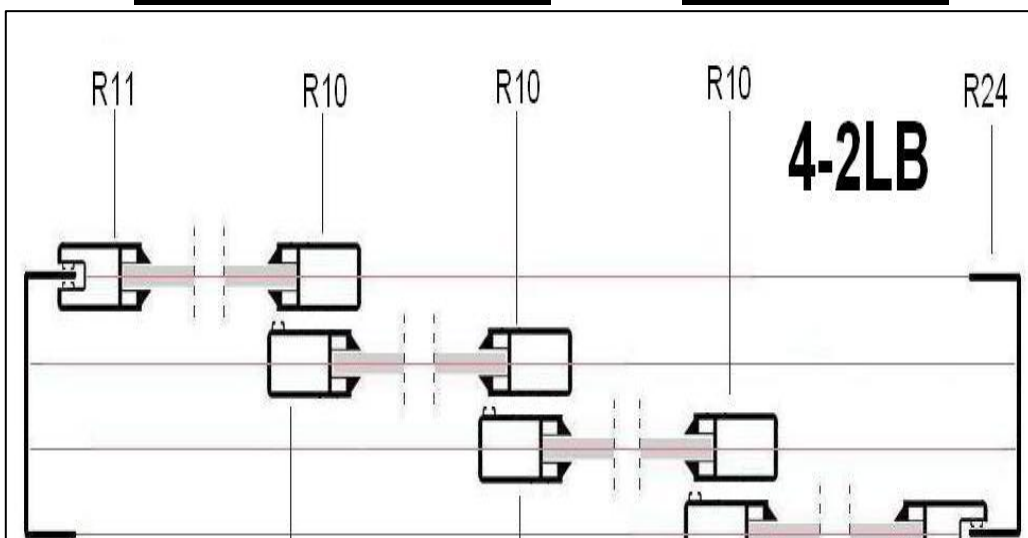

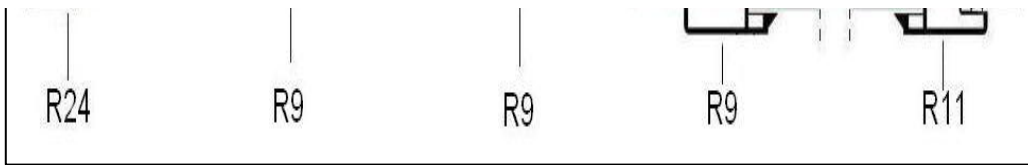

**4-2L B Komar**

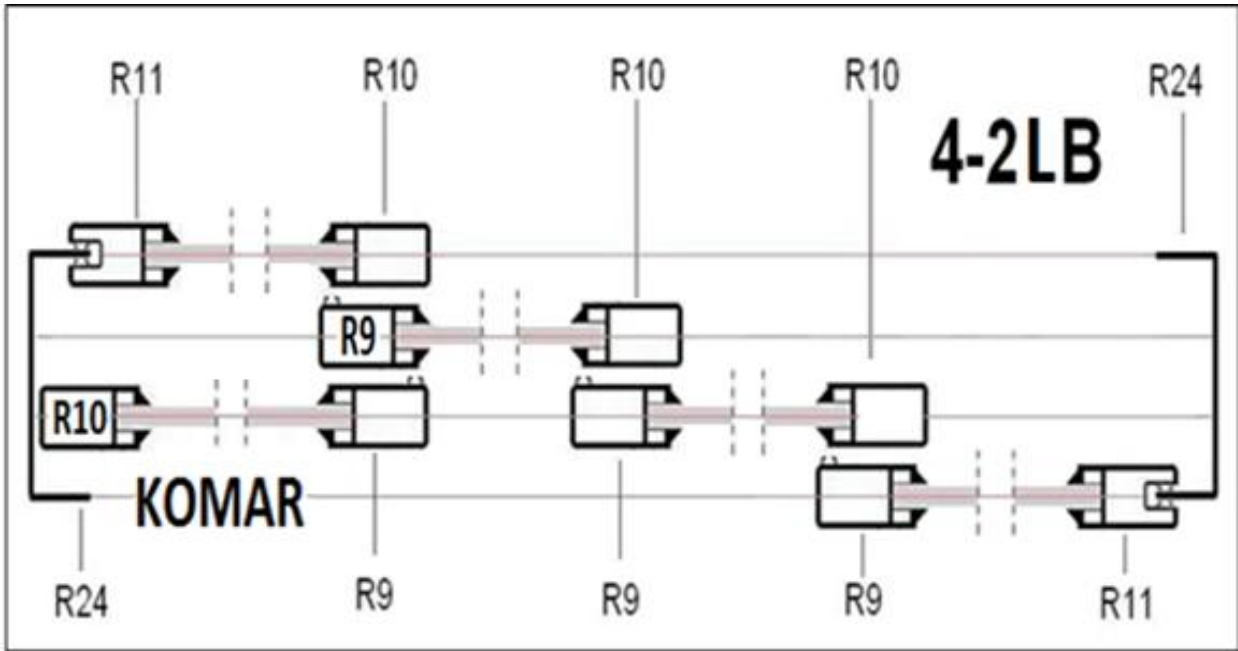

**4-2LB - Kot**

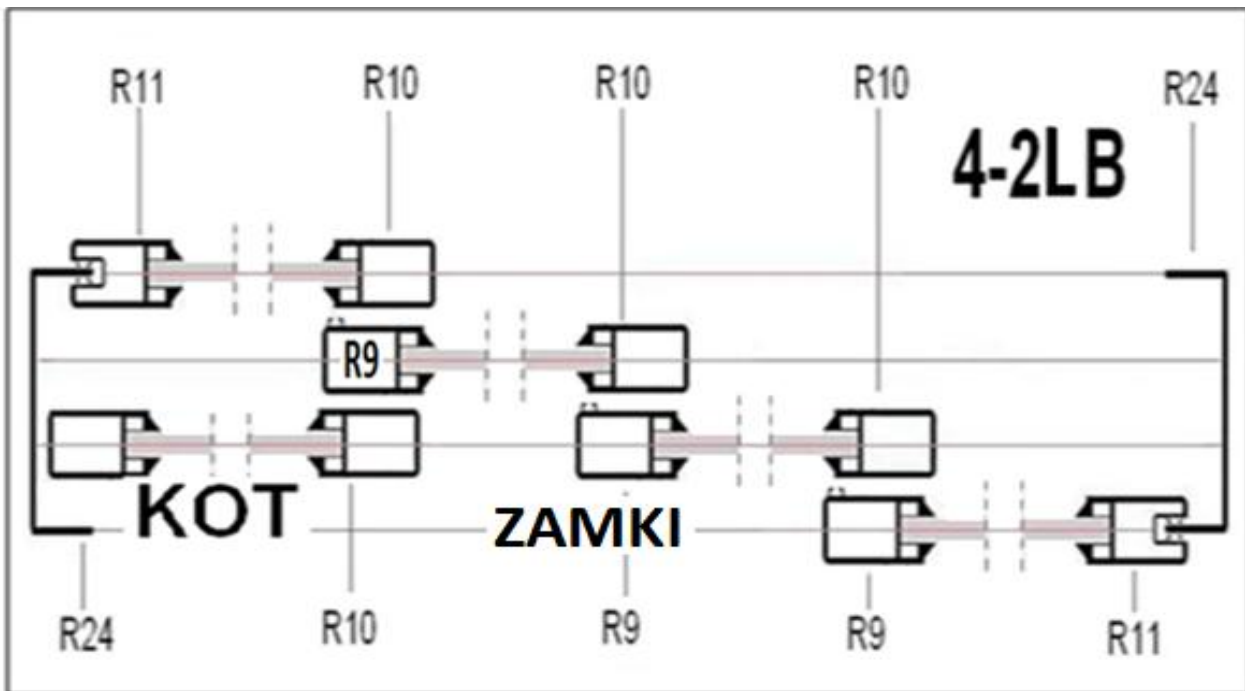

**4-2LB - Kot x 2**

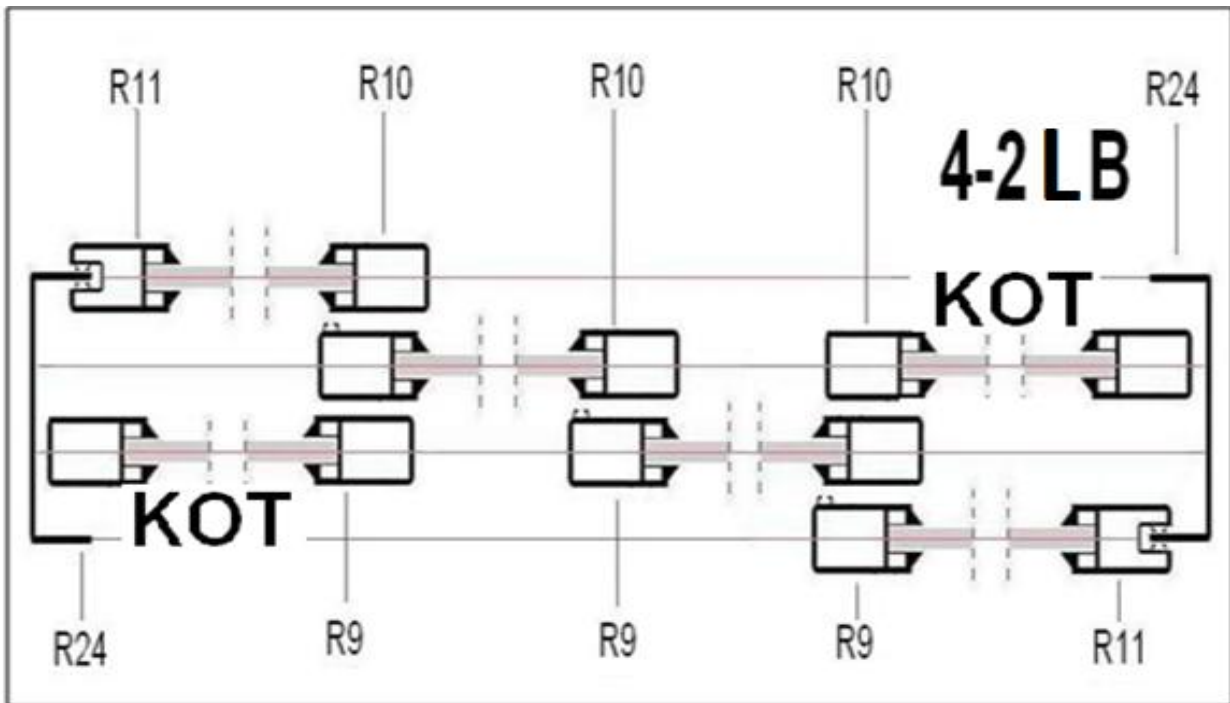

4-5.

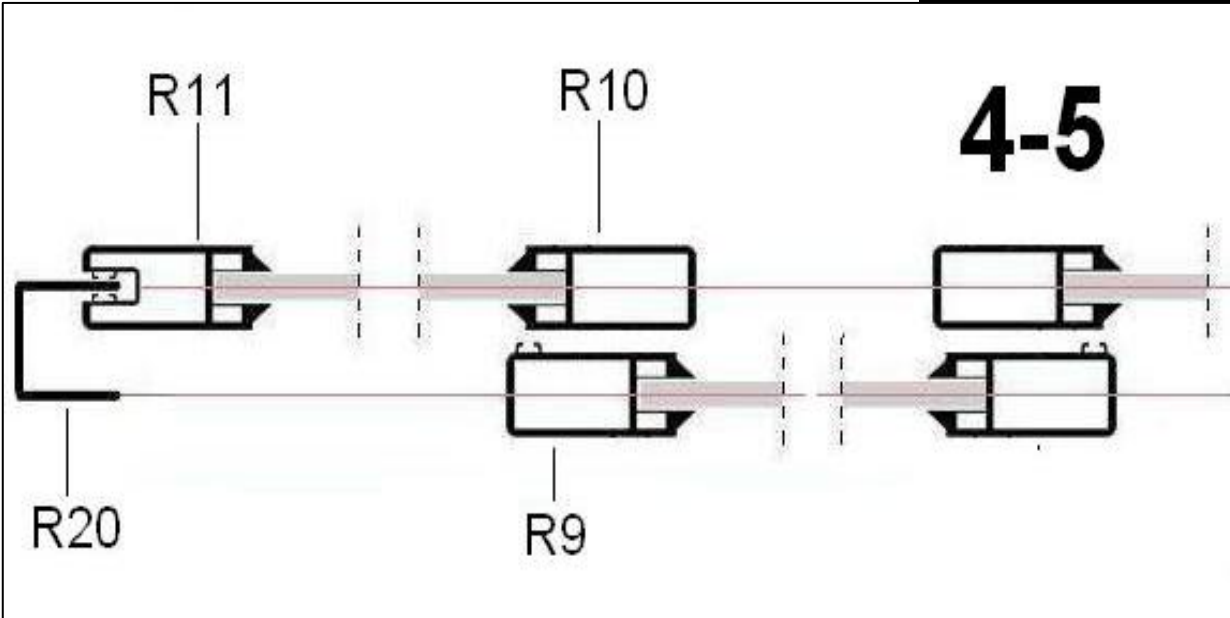

4-5 KOT

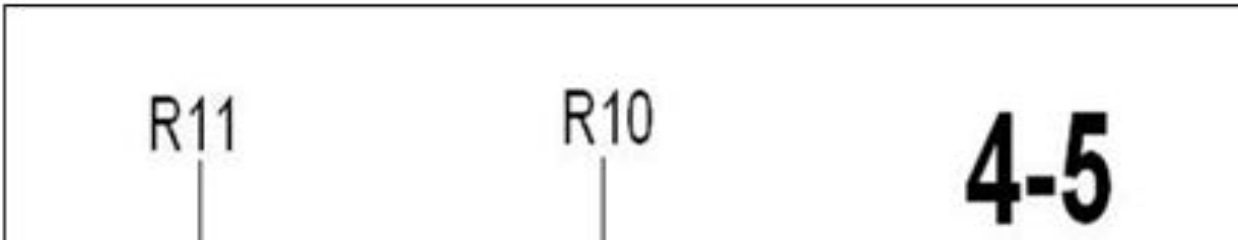

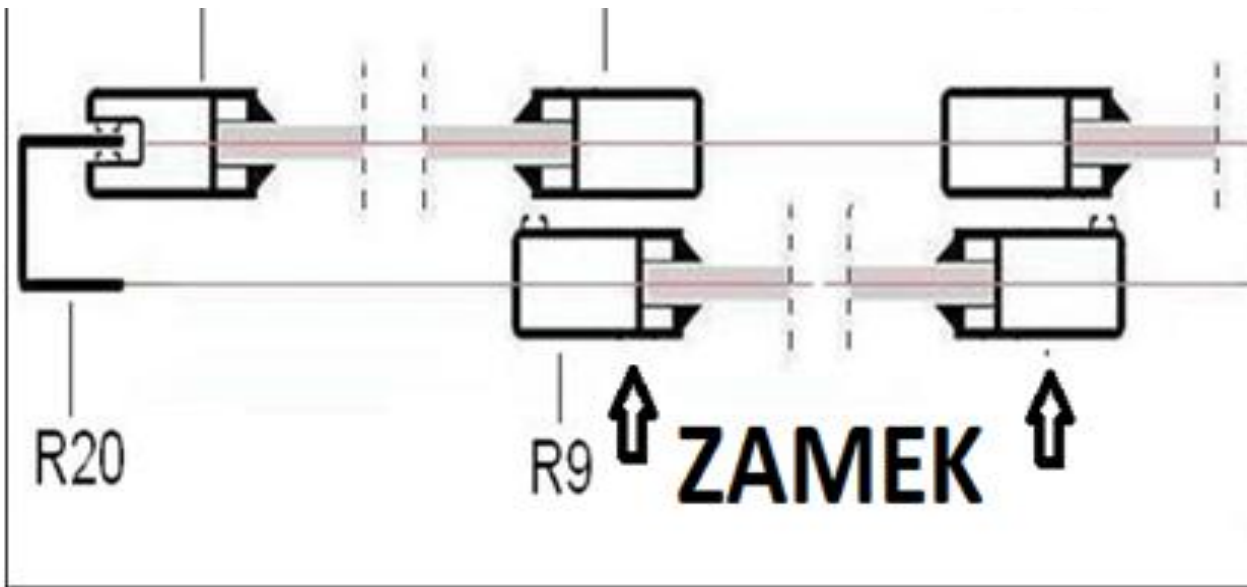

4-5 KOT-B

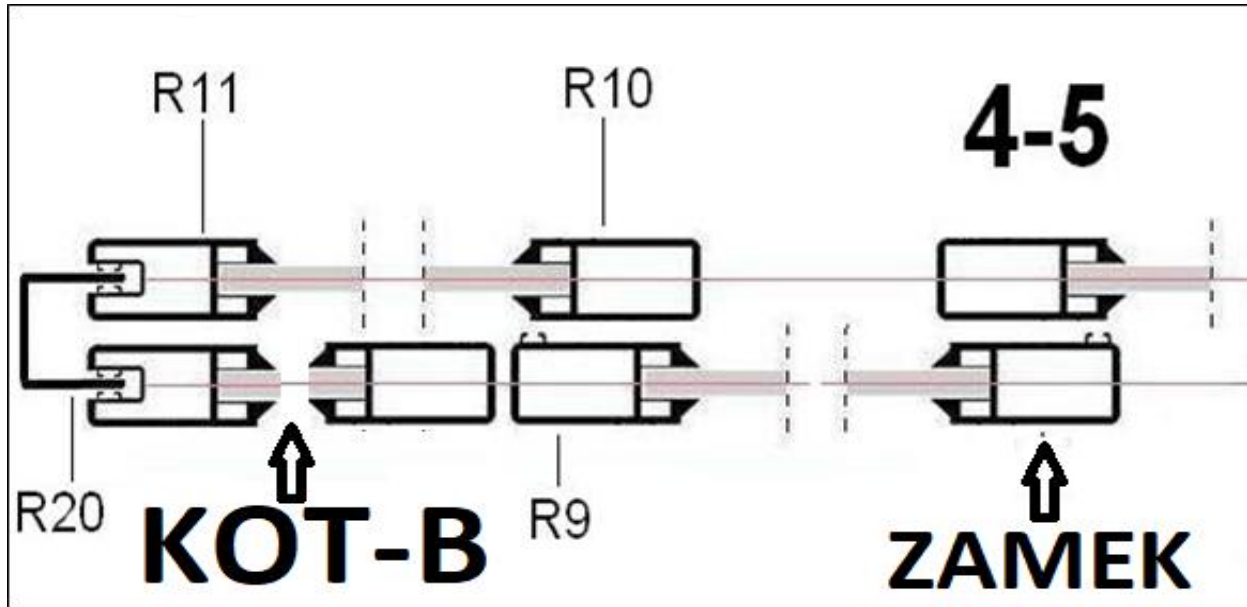

4-5 KOT-A+B

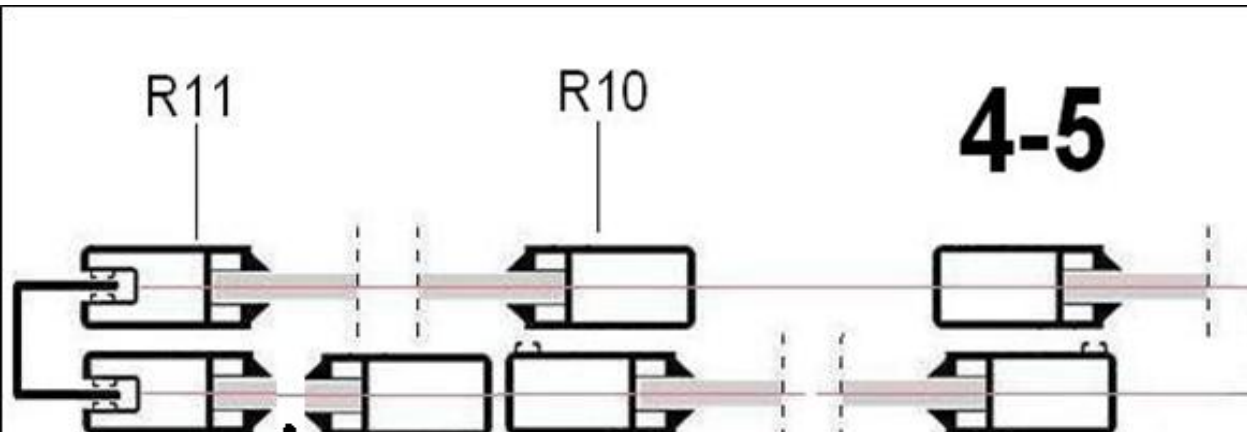

**KOT-B**



R9

**ZAMEK**



**4-5 KOMAR-A**

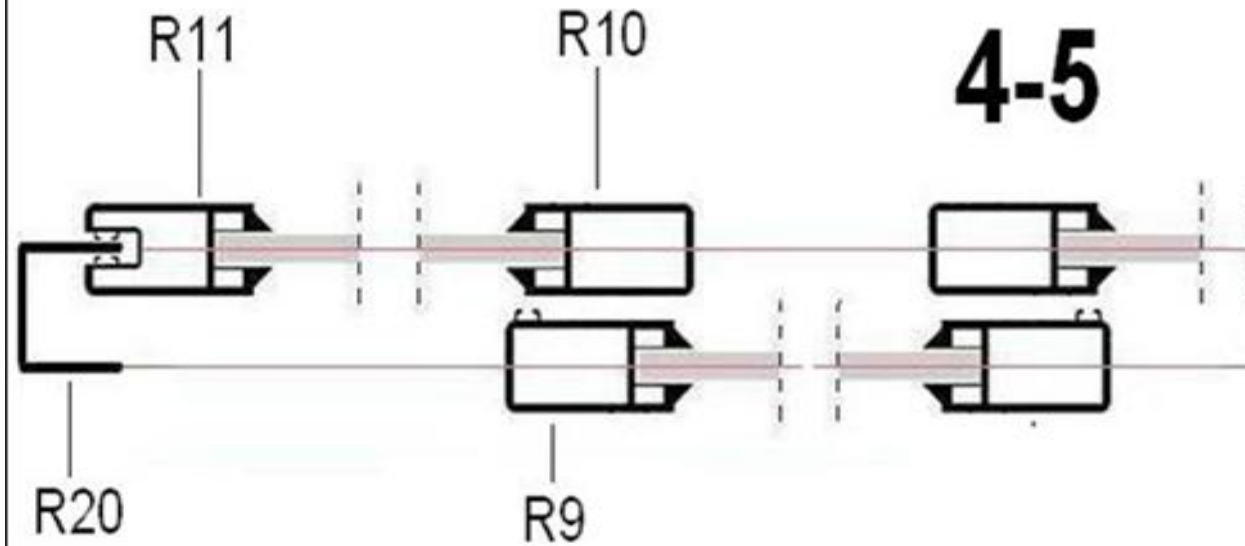

**4-5 KOMAR-B**

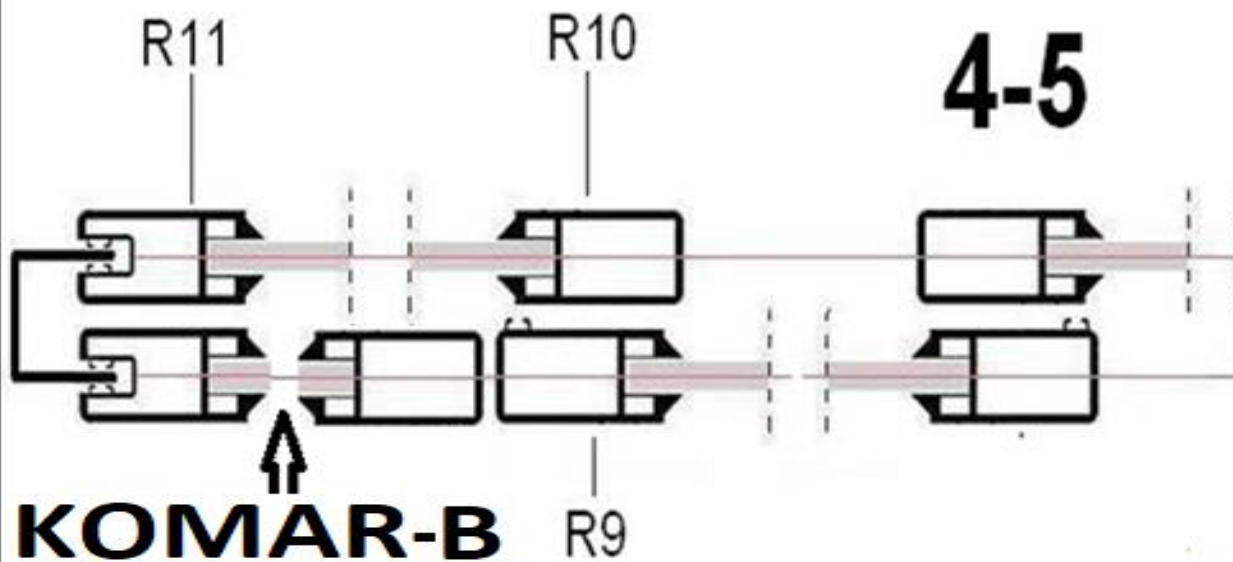

**KOMAR-B**

4-5 KOMAR A+B

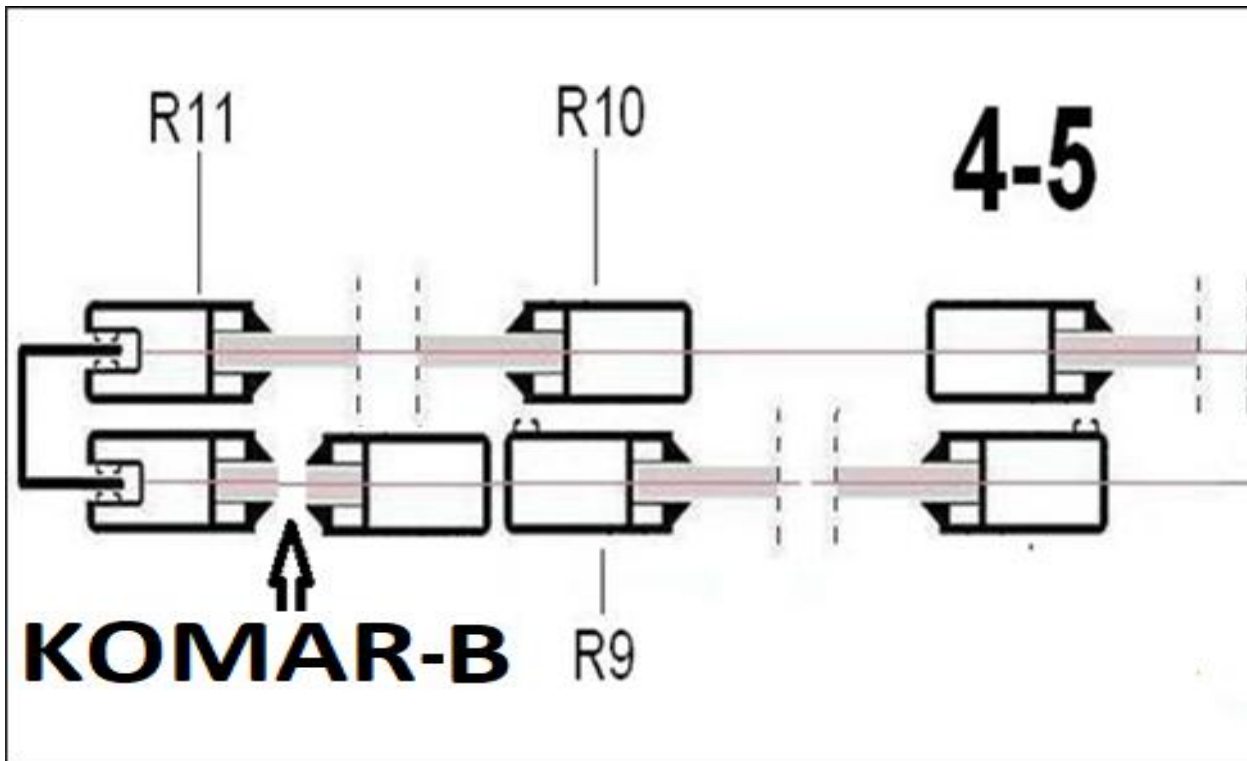

4-5A

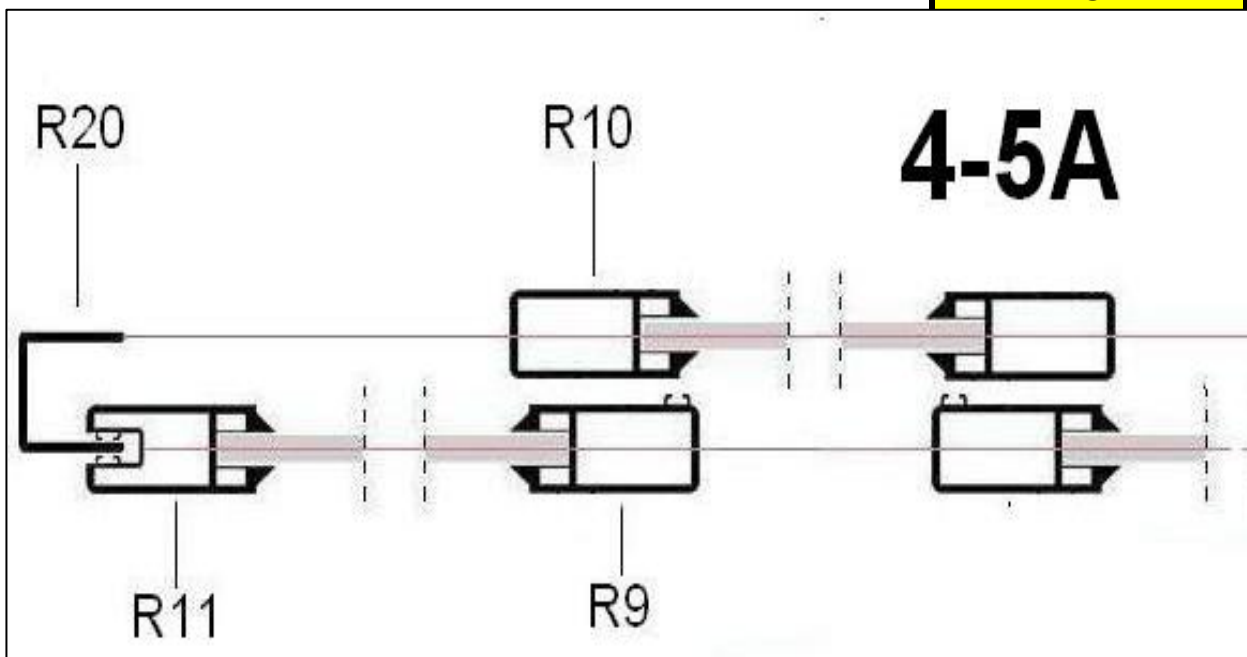

4-6

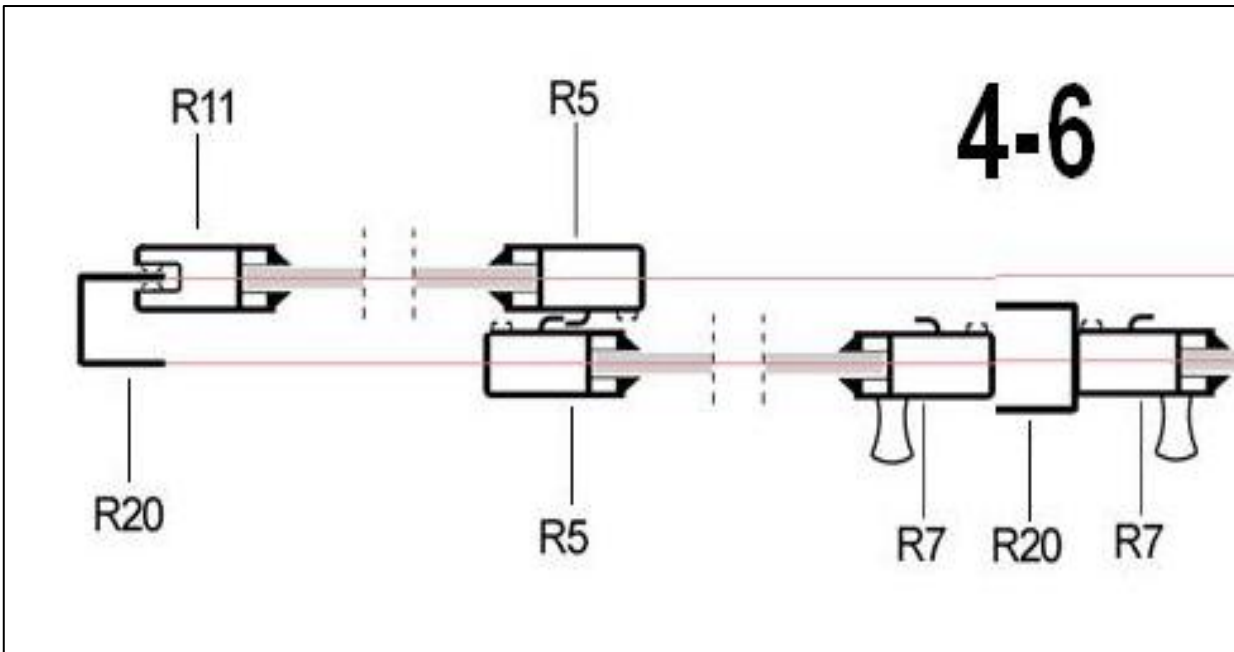

4-7

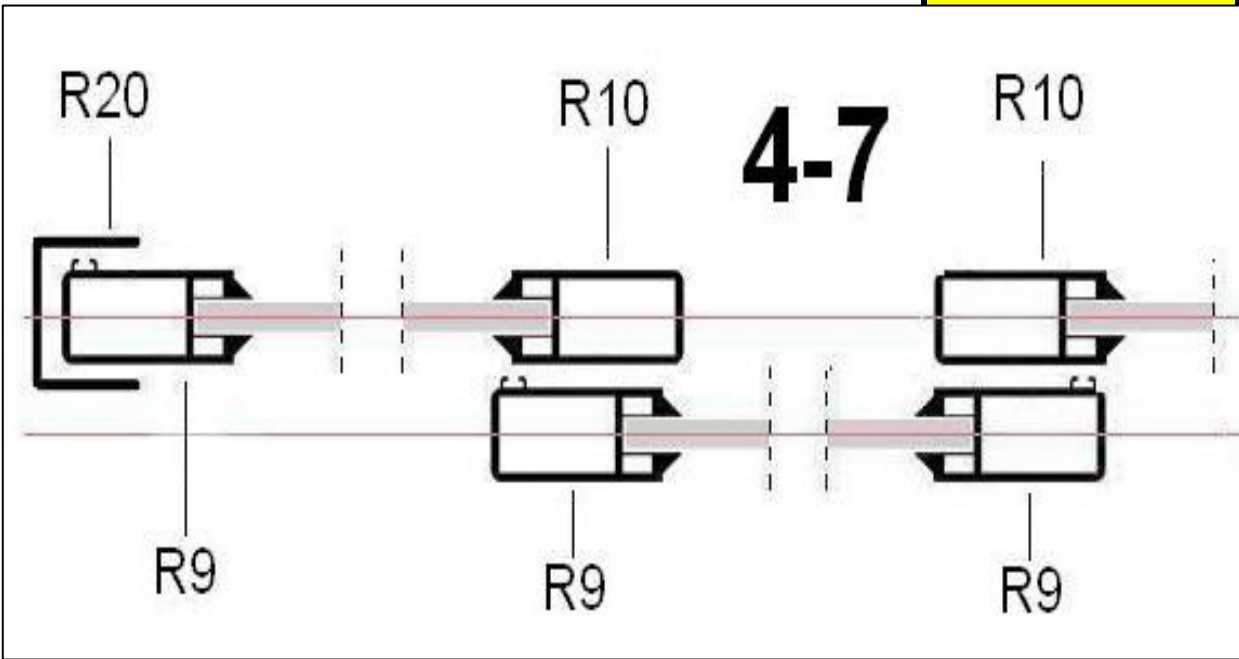

4-8



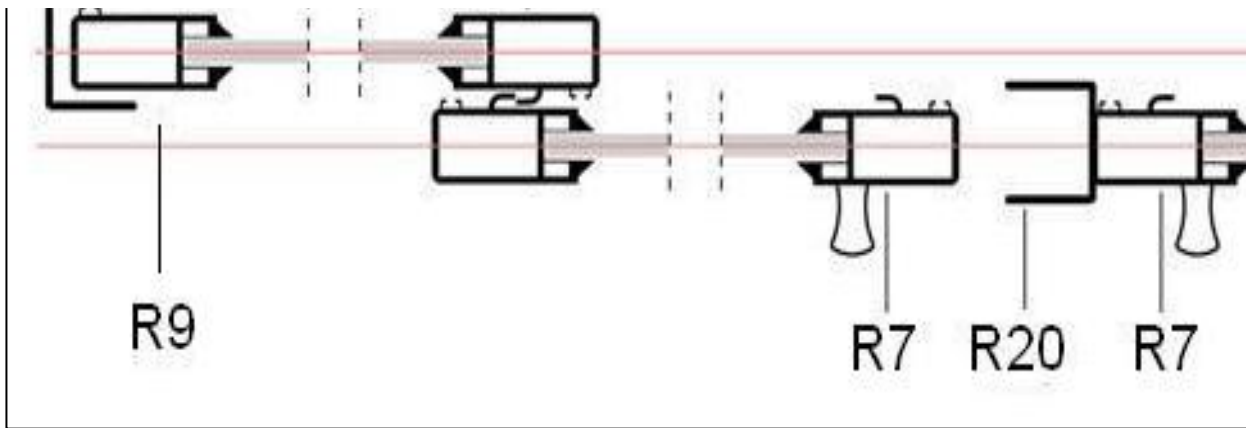

4-8 - Kot

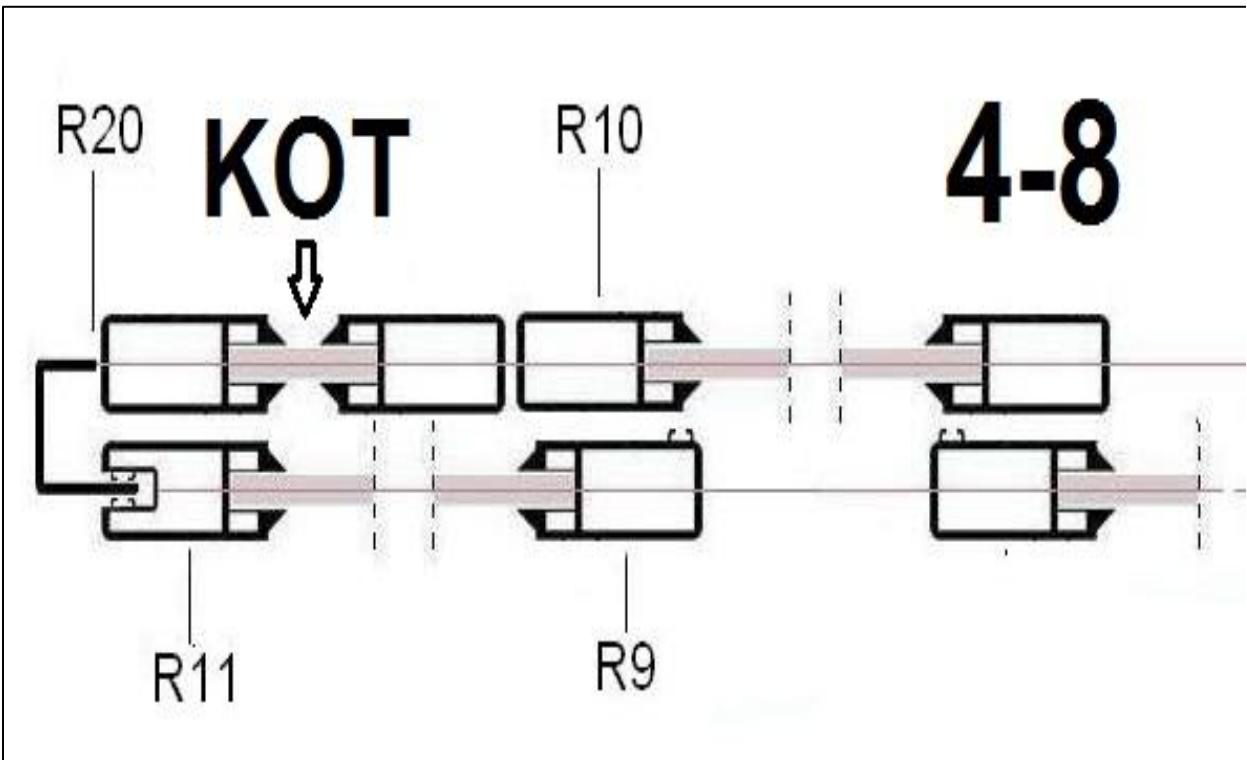

4-9

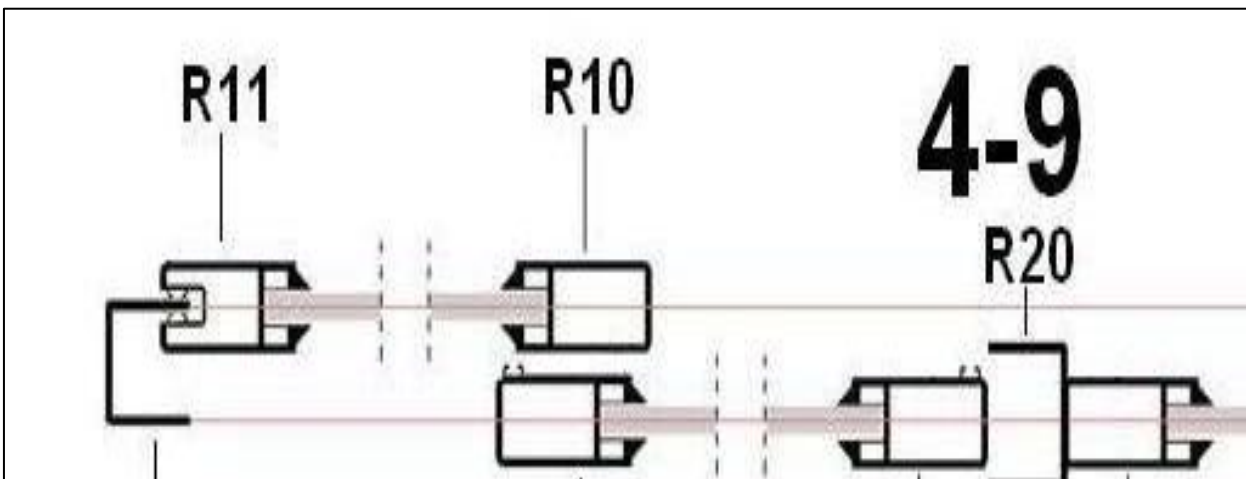

R20

R9

R9

R10

4-9 — Komar x 2

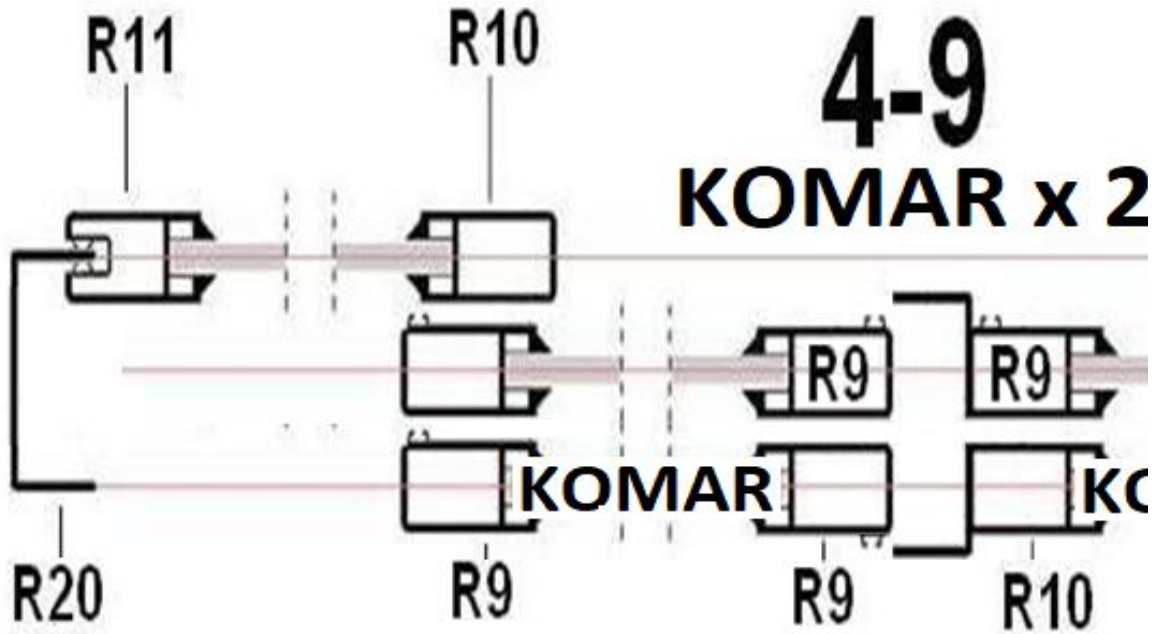

4-1P

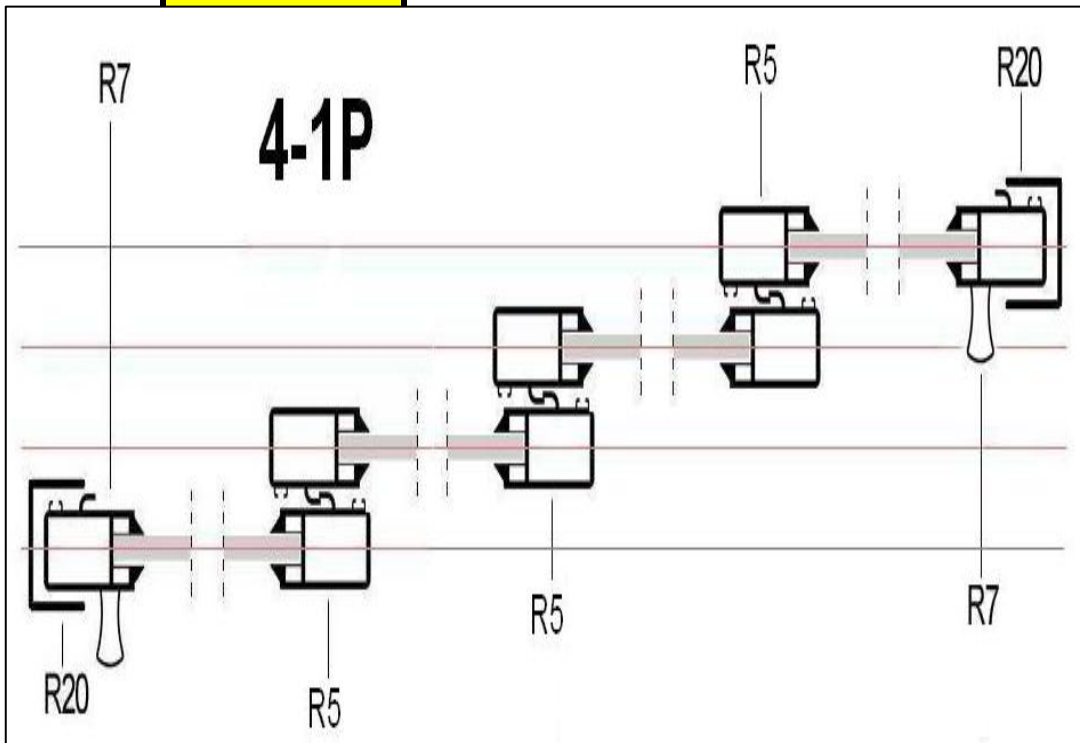

4-1P A

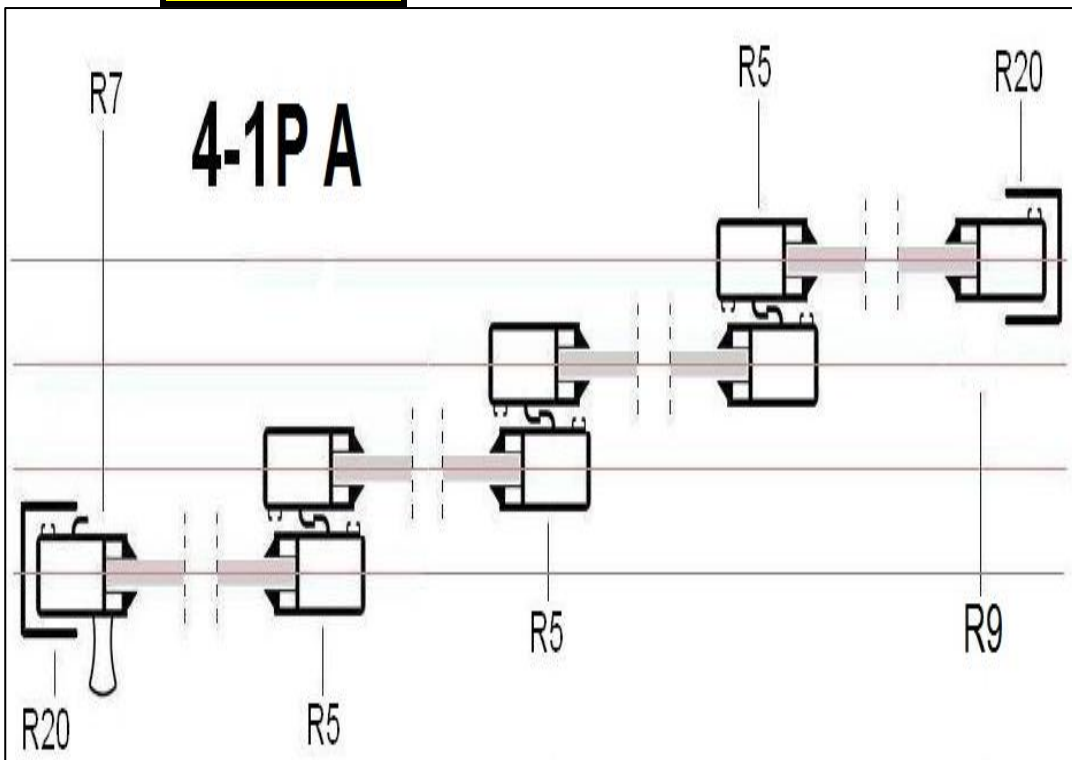

4-1P B

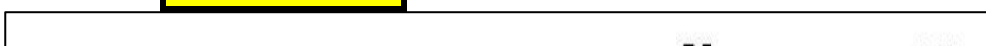

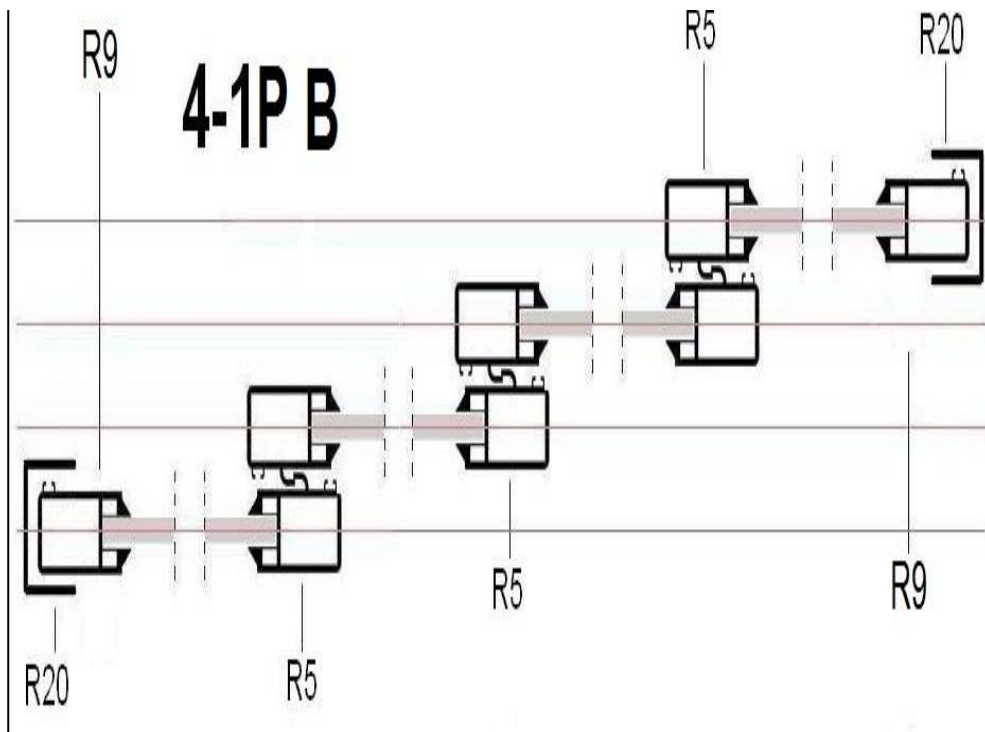

**4-1PC**

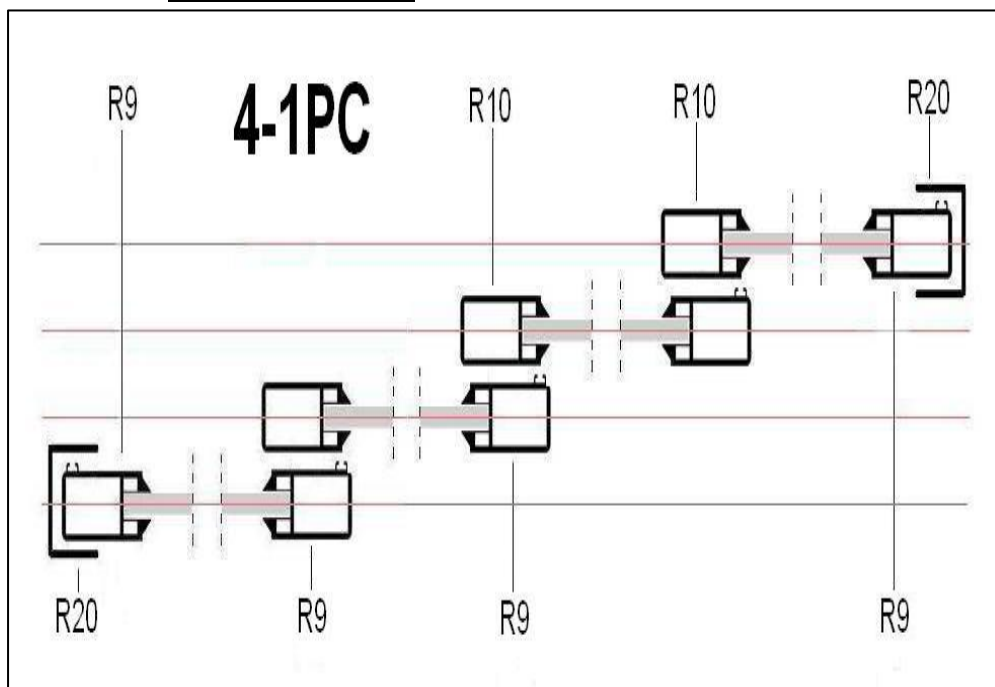

**4-2P**

**4-2P REGULOWANY**

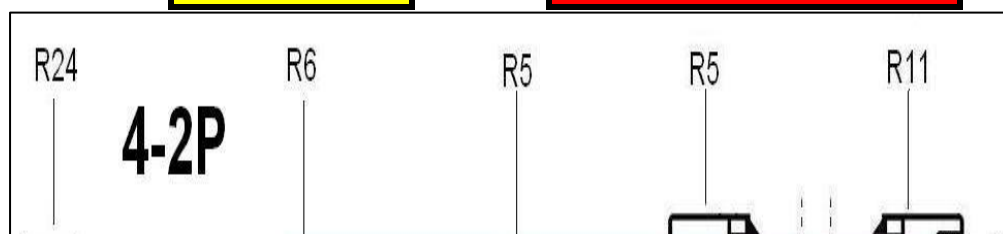

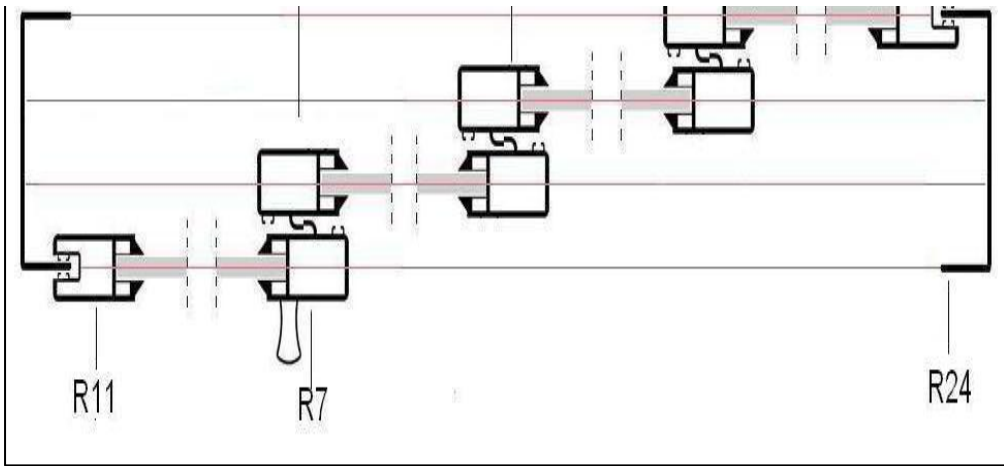

**4-2P A**

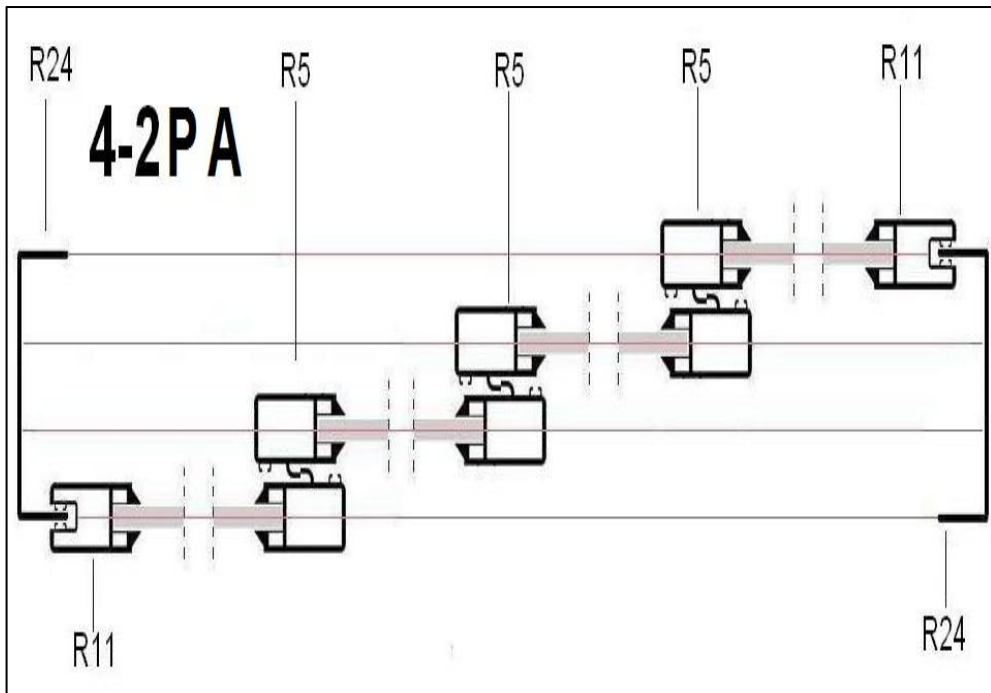

**4-2PB**

**4-2PB REGULOWANY**

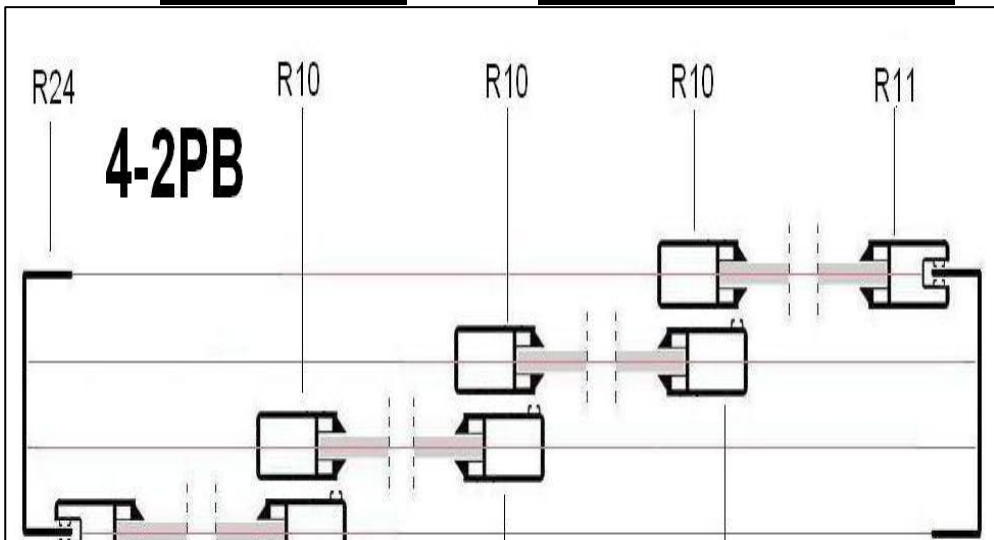

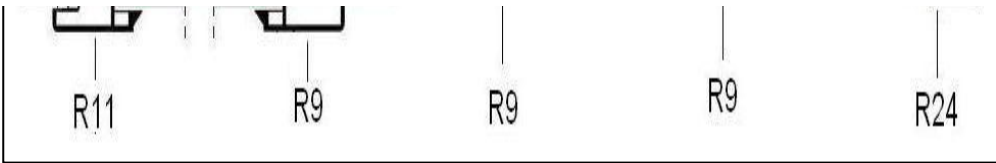

**4-2P B Komar**

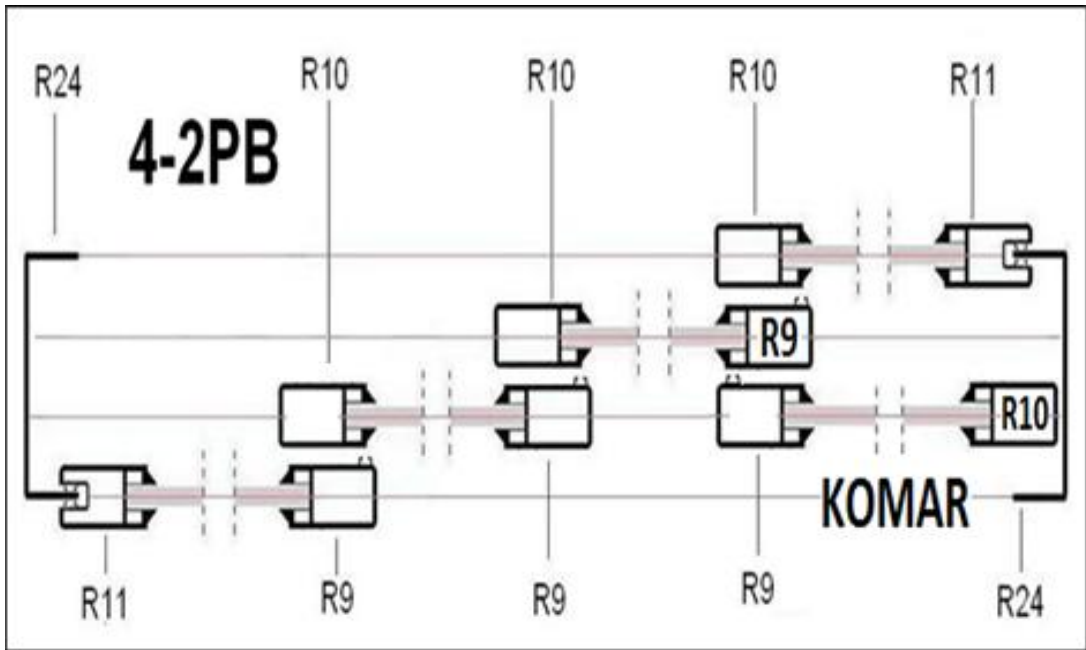

**4-2PB - Kot**

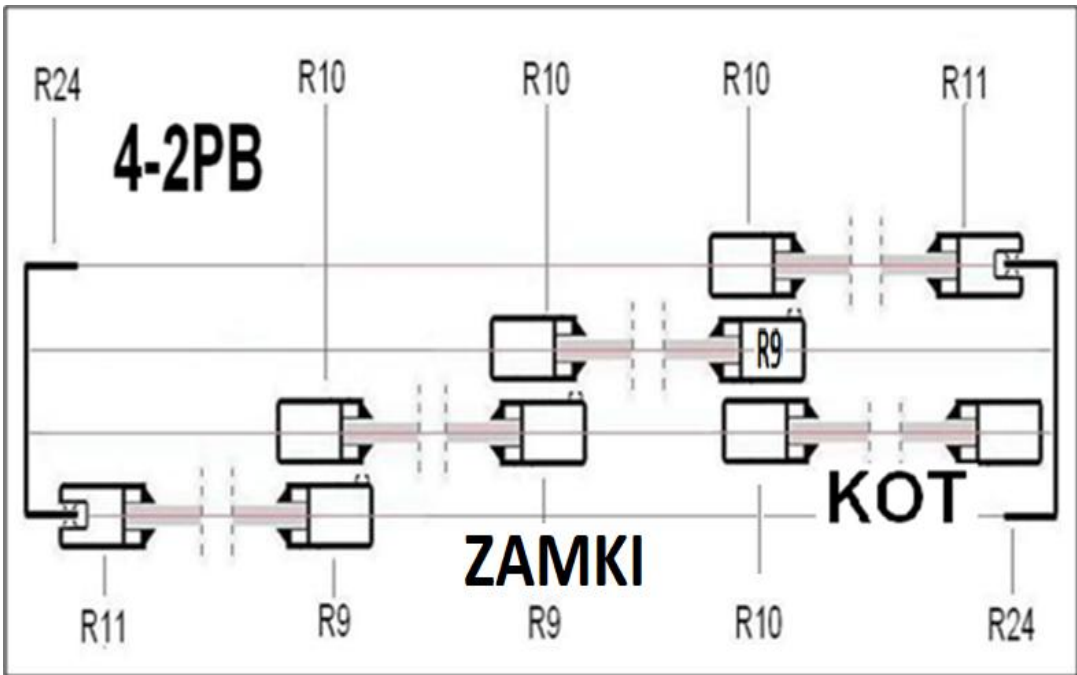

**4-2PB - Kot x 2**

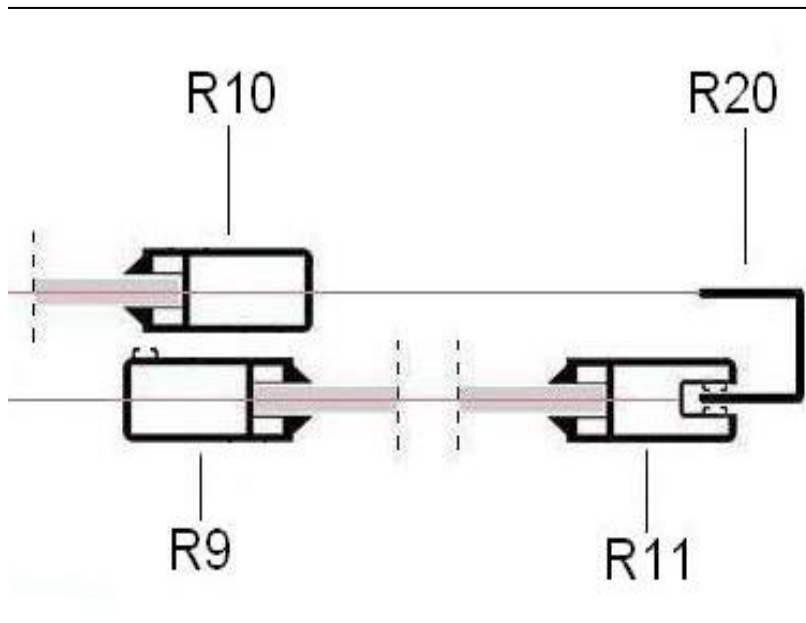
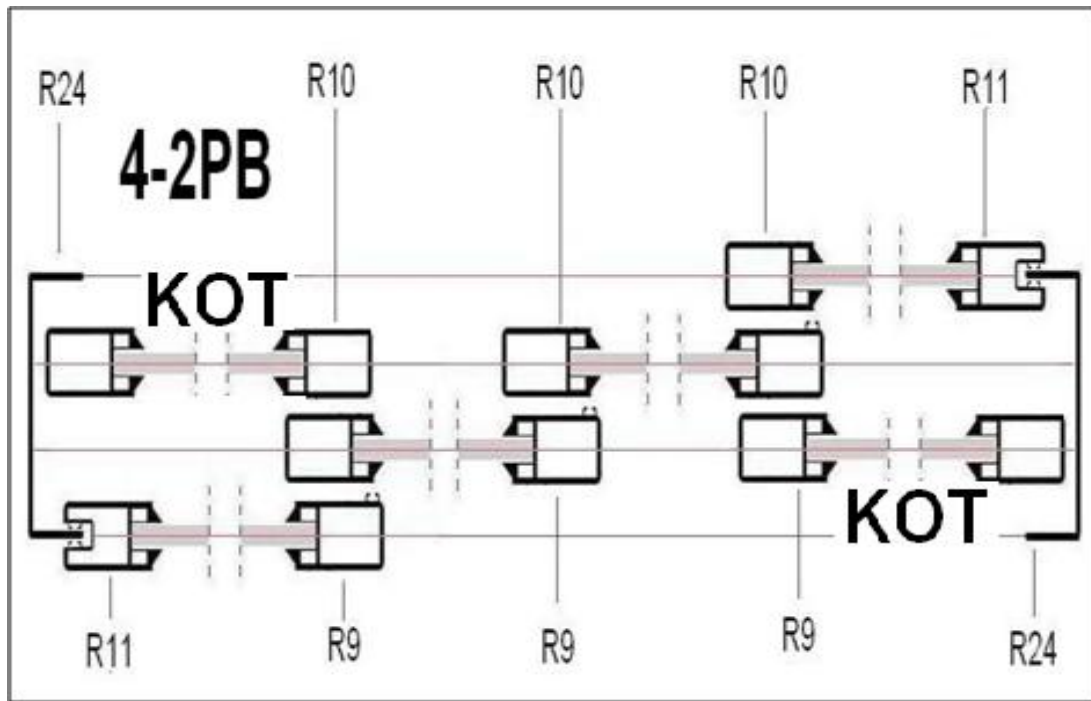

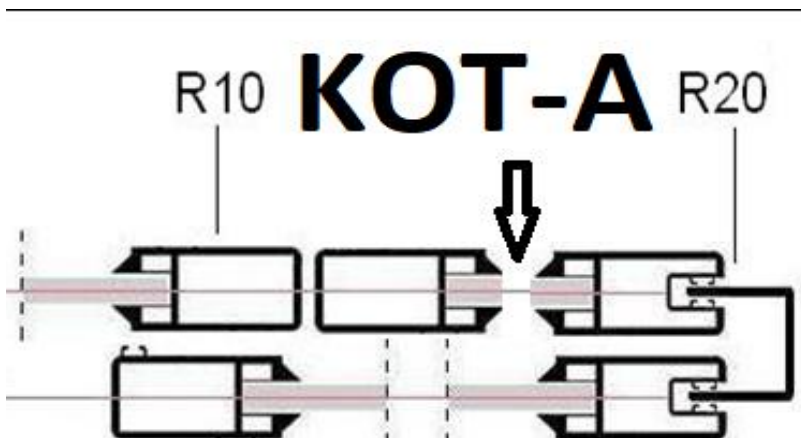
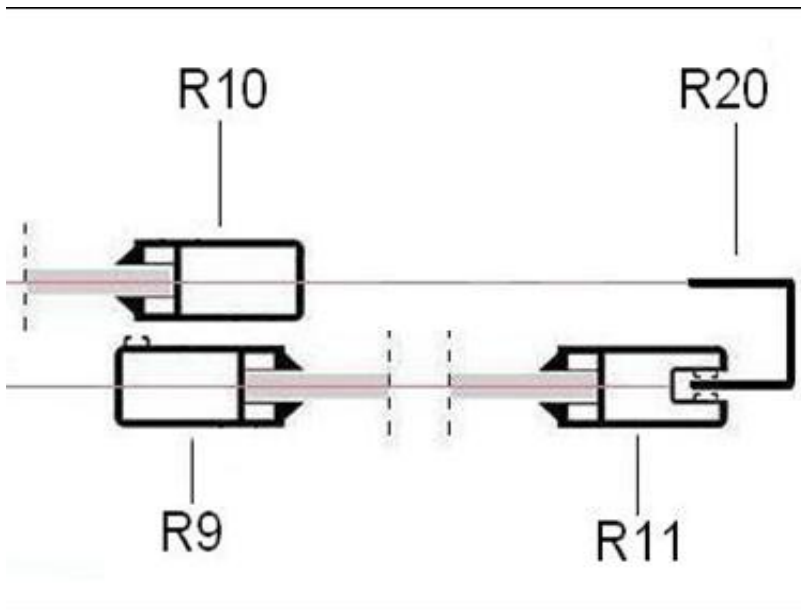
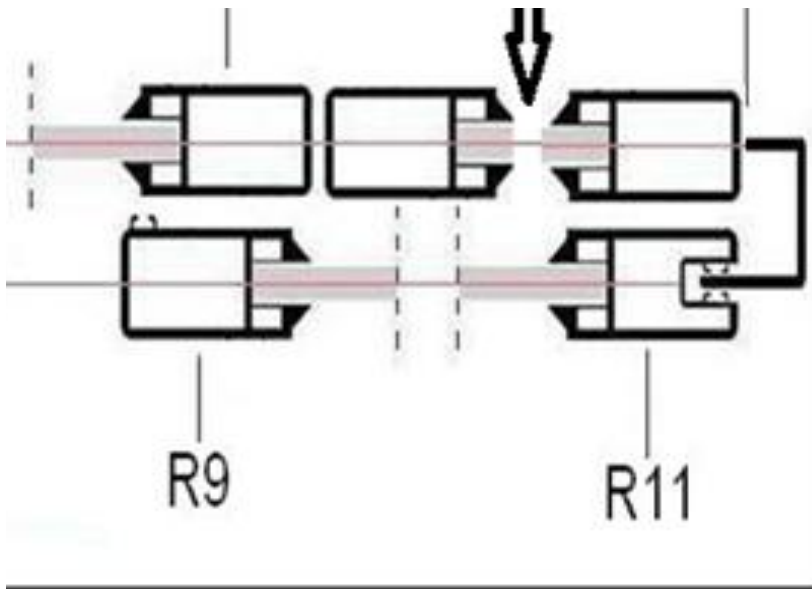

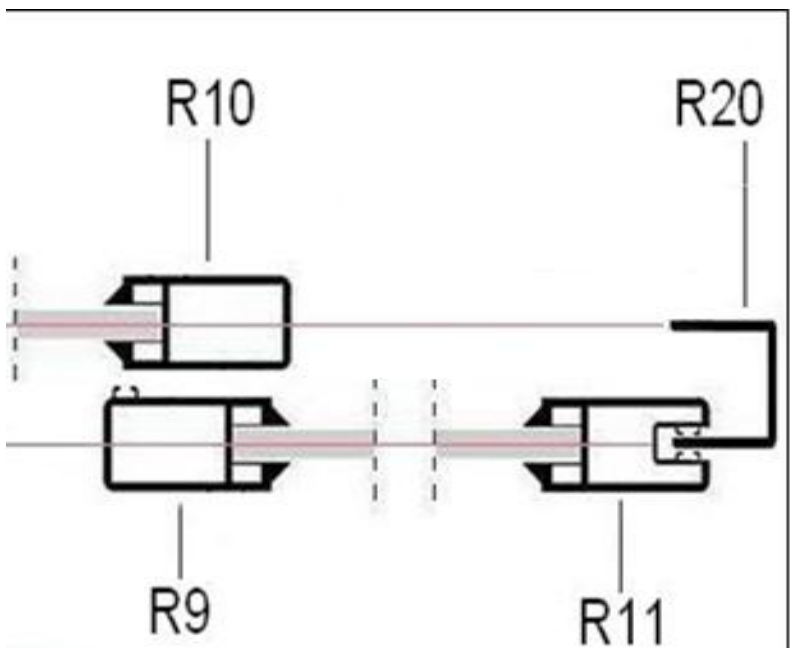
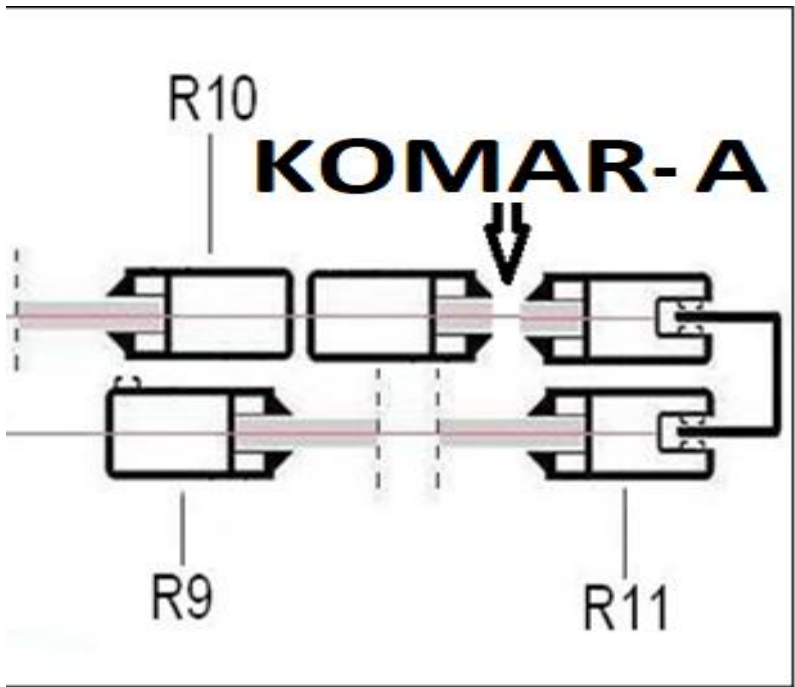

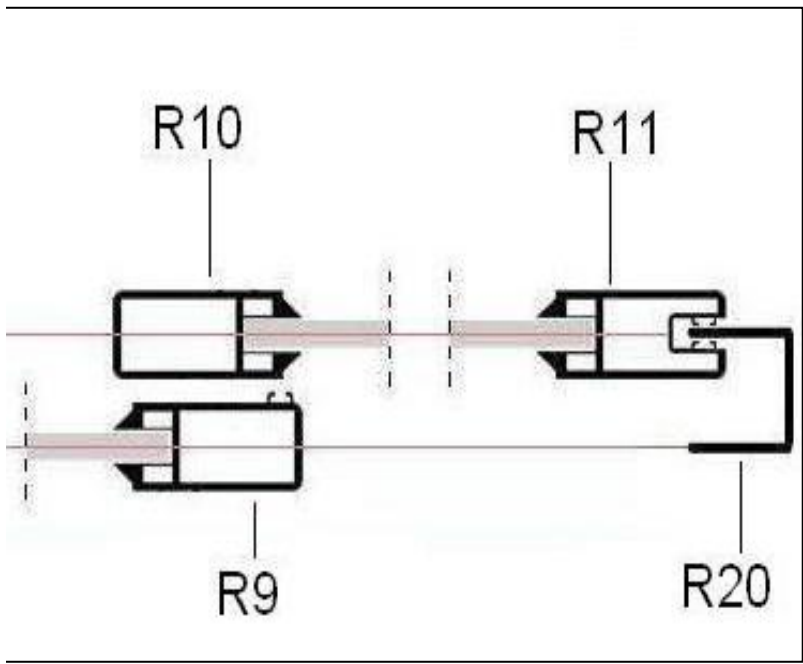
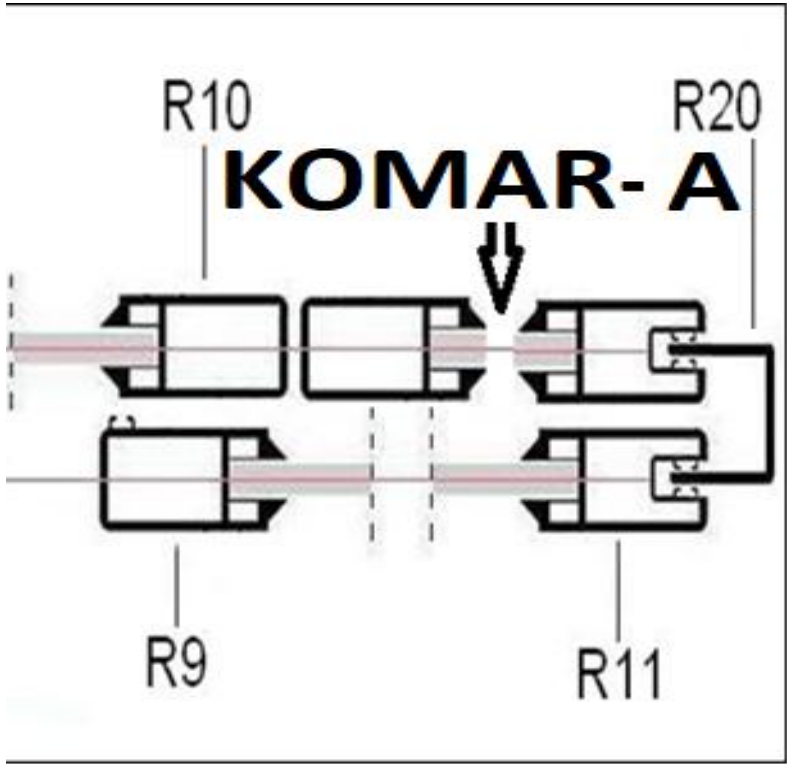

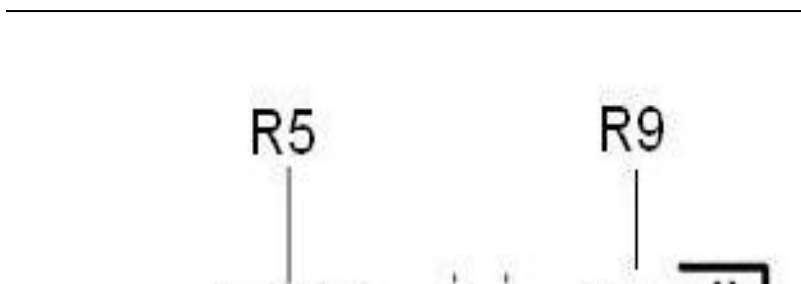
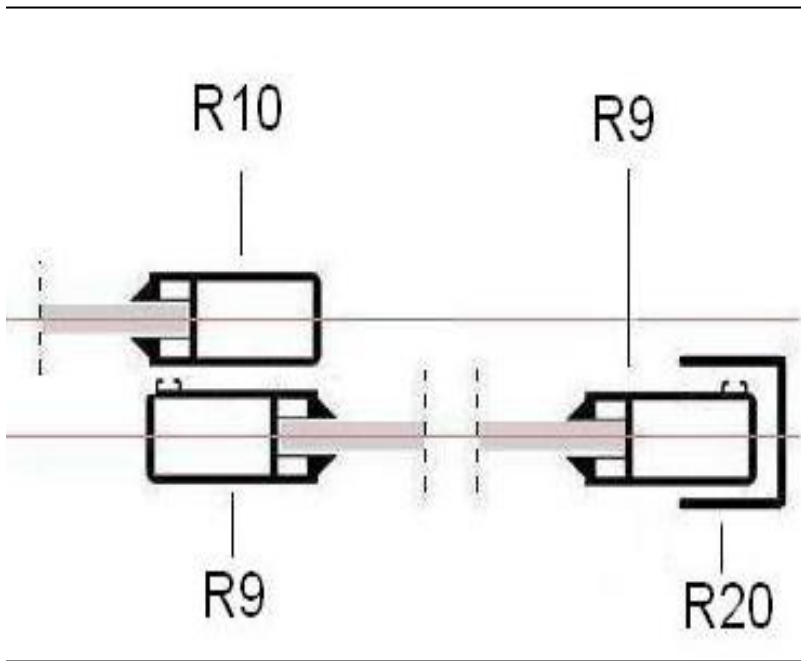
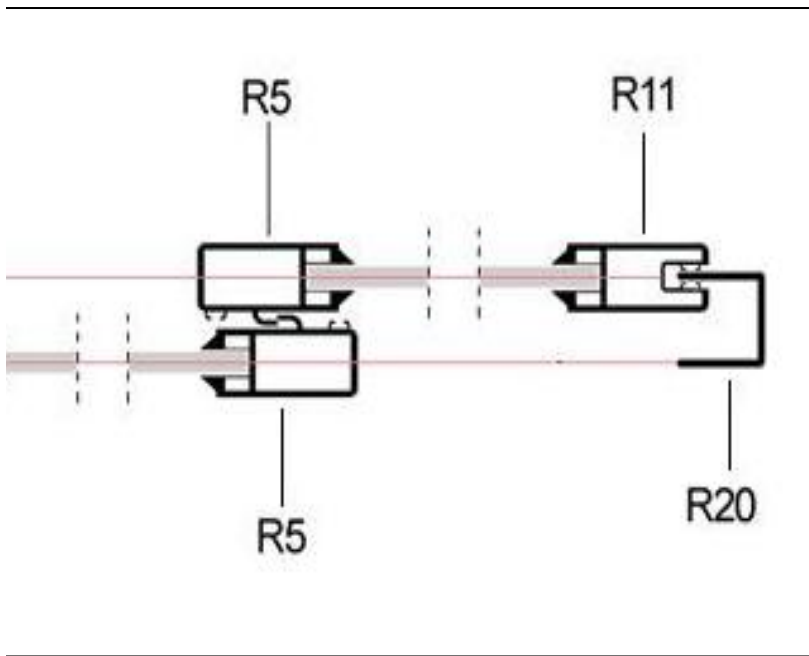

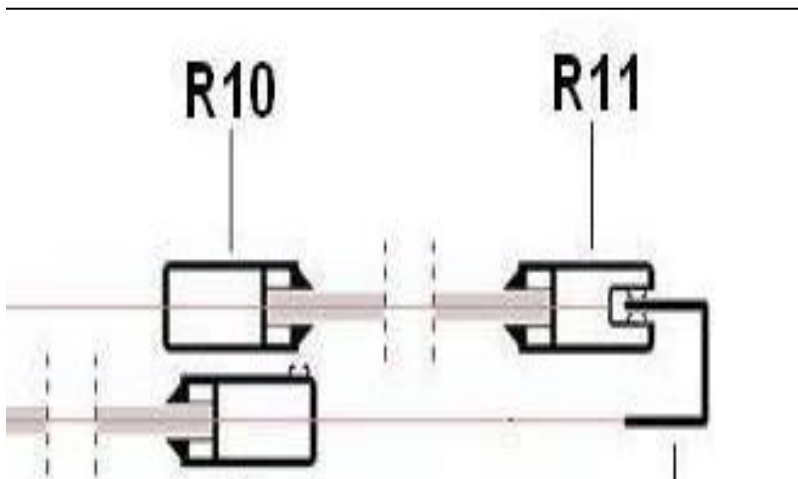
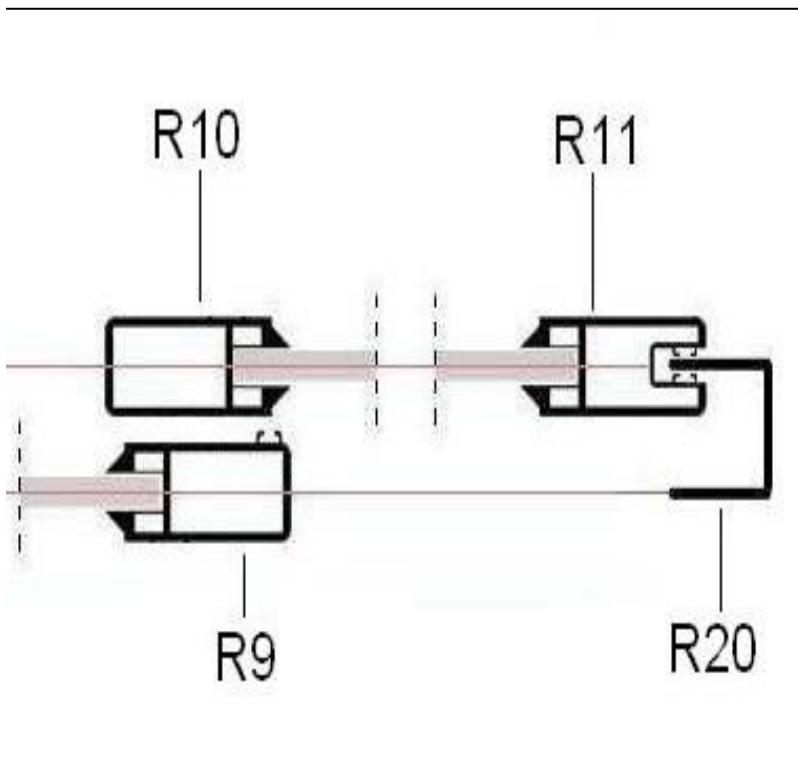
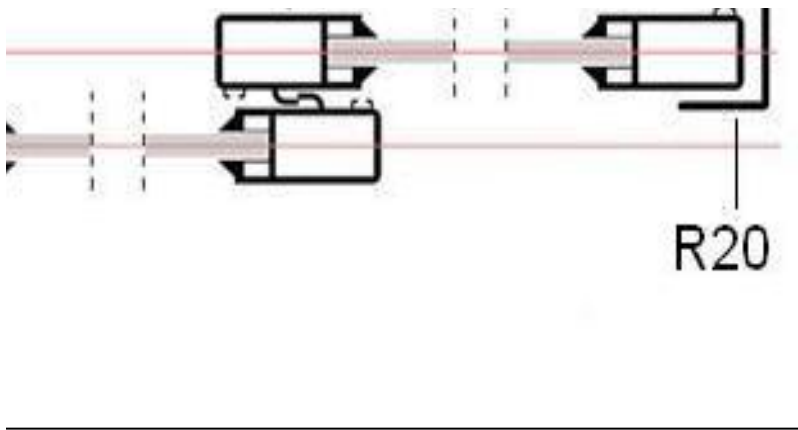

R9

R20

R10

R11

DMAR

R9

R20

